

# system VEGAS

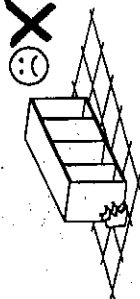

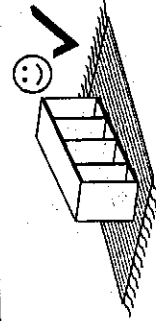

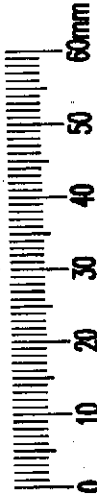

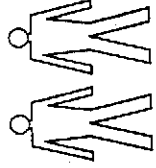
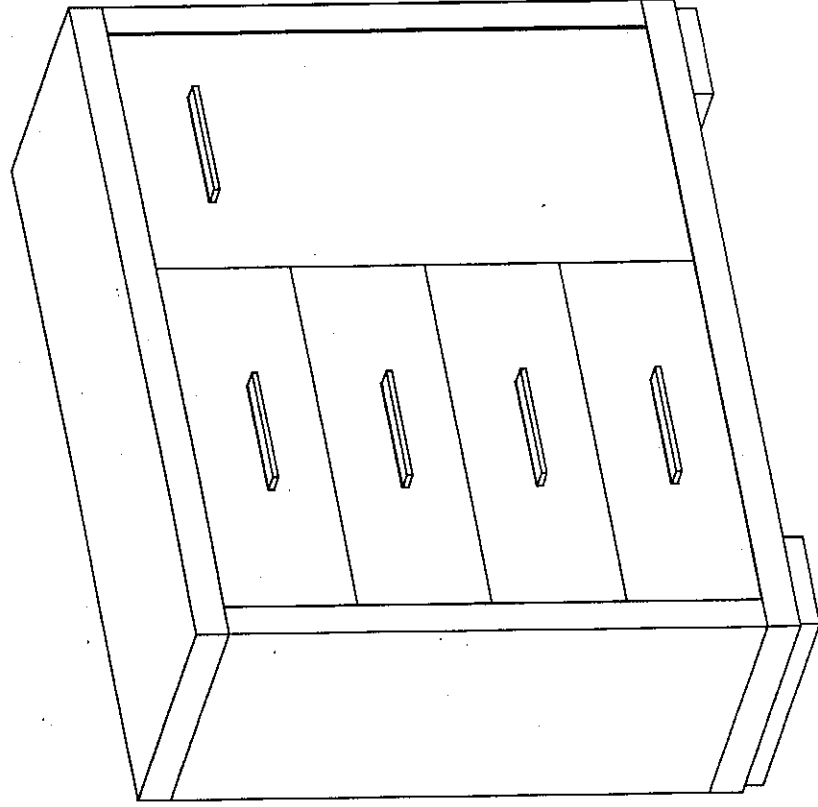





V-2

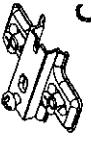
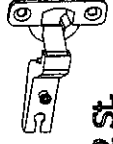

Narzędzia potrzebne do montażu

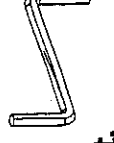

W przypadku reklamacji proszę o podanie numeru pakowacza znajdującego się na kartonie

 <b>P - 4 St.</b>	 <b>N - 10 St.</b> 4 x 30 mm	 <b>M - 80 St.</b> 3 x 30 mm	 <b>H - 1 St.</b>	 <b>F - 16 St.</b>
 <b>E - 55 St.</b>	 <b>T - 4 Kpl.</b>	 <b>C - 2 St.</b>	 <b>D - 2 St.</b>	 <b>L - 12 St.</b>
 <b>B - 28 St.</b>	 <b>K - 12 St.</b>	 <b>Z - 1 St.</b>	 <b>J - 32 St.</b> 5 x 13 mm	 <b>S - 1 St.</b>

I

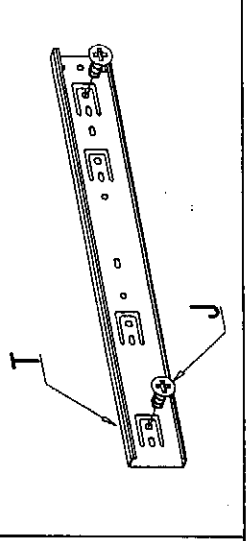
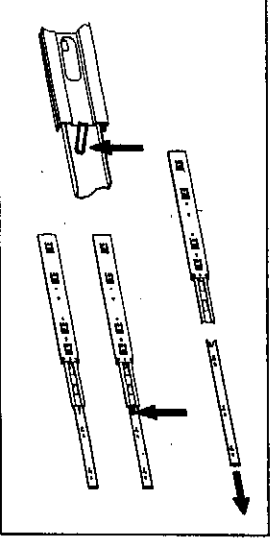
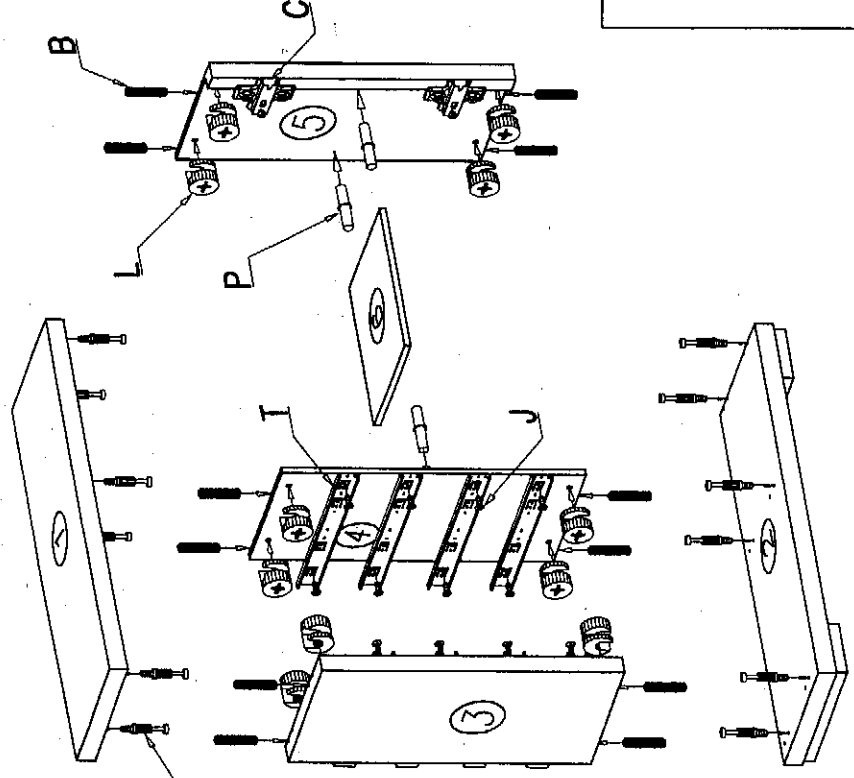

II

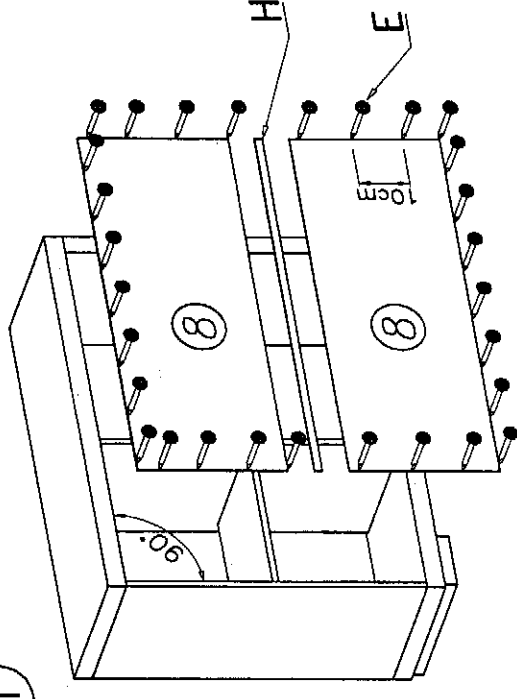

III

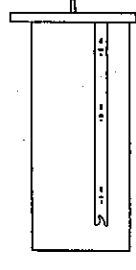
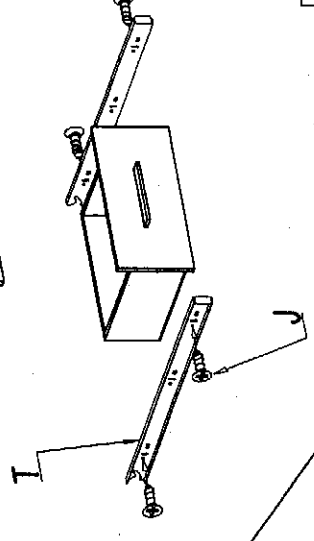
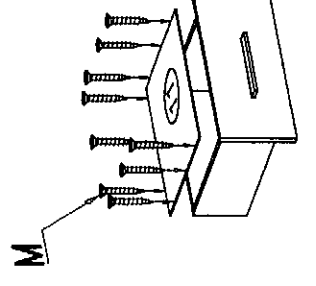
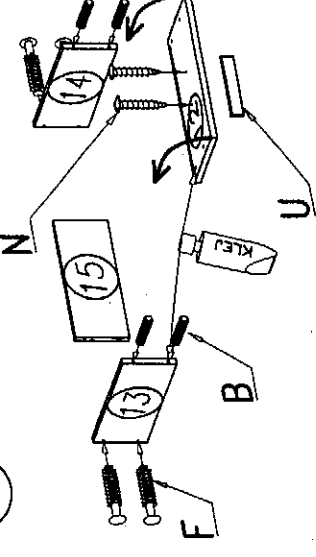

IV

