

system VEGAS

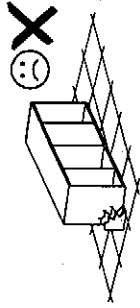

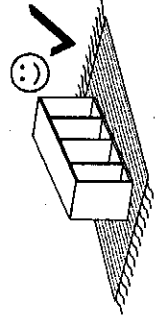

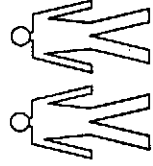

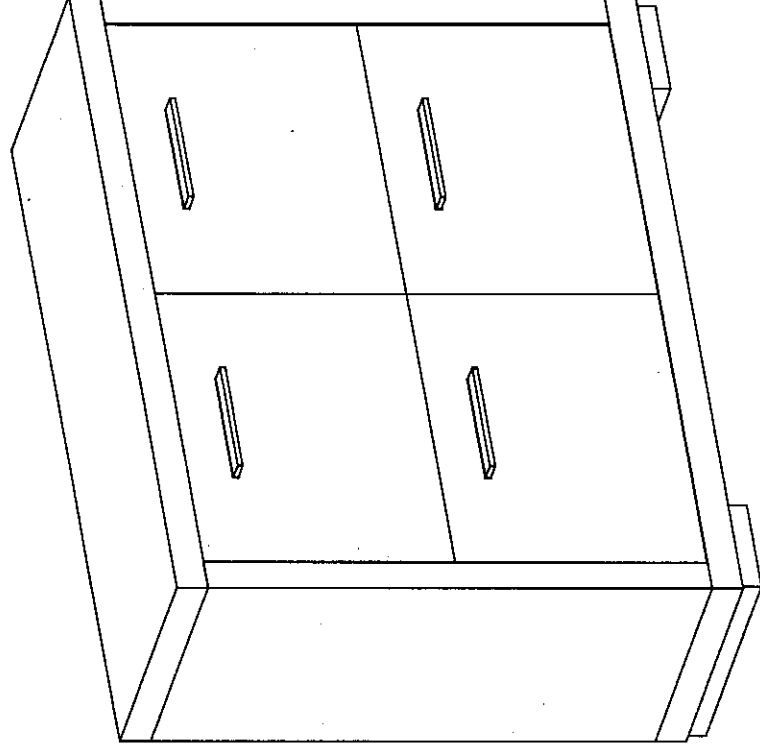
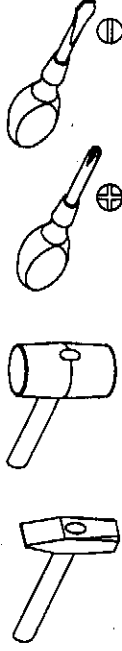

V-5

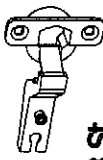
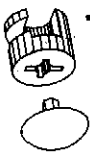

Narzędzia potrzebne do montażu

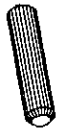

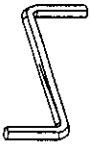
W przypadku reklamacji proszę o podanie numeru pakowacza znajdującego się na kartonie

 <p>N - 8 St. 4 x 30 mm</p>	 <p>U - 4 St.</p>	 <p>C - 8 St.</p>	 <p>D - 8 St.</p>	 <p>L - 16 St.</p>
 <p>E - 50 St.</p>	 <p>B - 16 St.</p>	 <p>K - 16 St.</p>	 <p>Z - 1 St.</p>	 <p>G - 16 St. 3,5 x 16 mm</p>  <p>H - 10 St.</p>

I

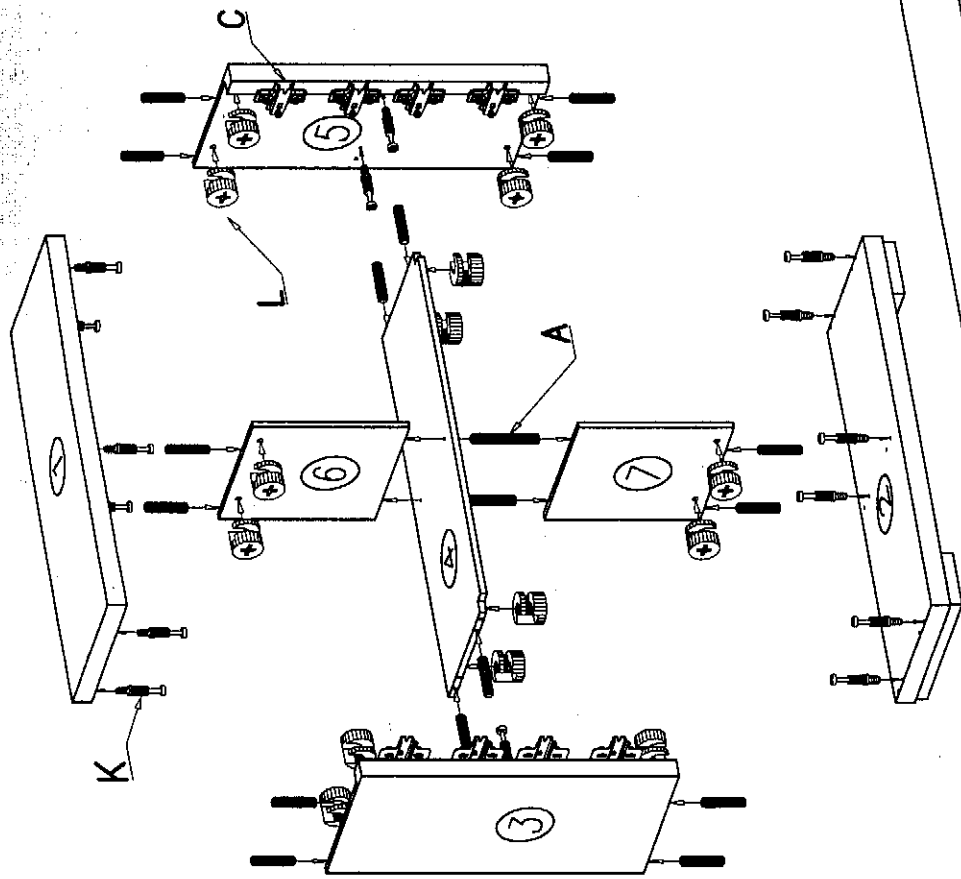

II

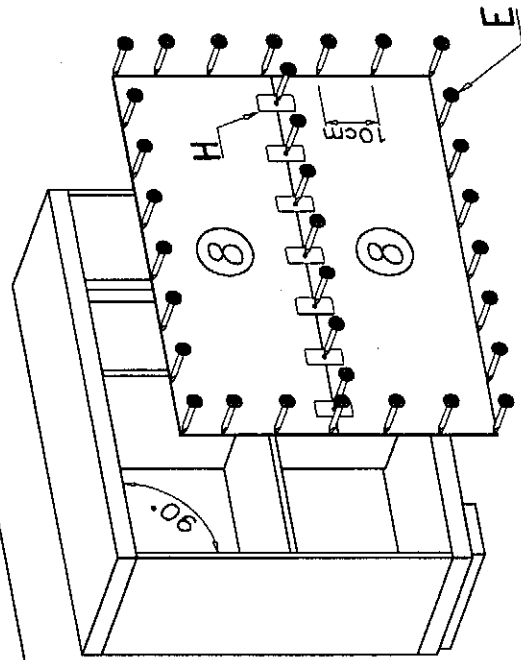

III

