

INDIANA

I-1

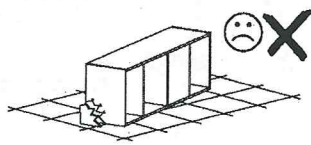

Narzędzia potrzebne do montażu

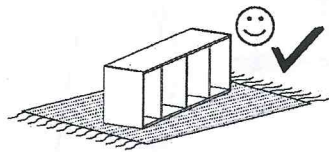
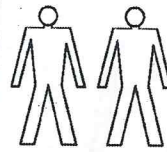
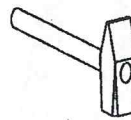

UWAGA!
MONTOWANIE USZKODZONYCH
ELEMENTÓW POWODUJE UTRATĘ
GWARANCJI

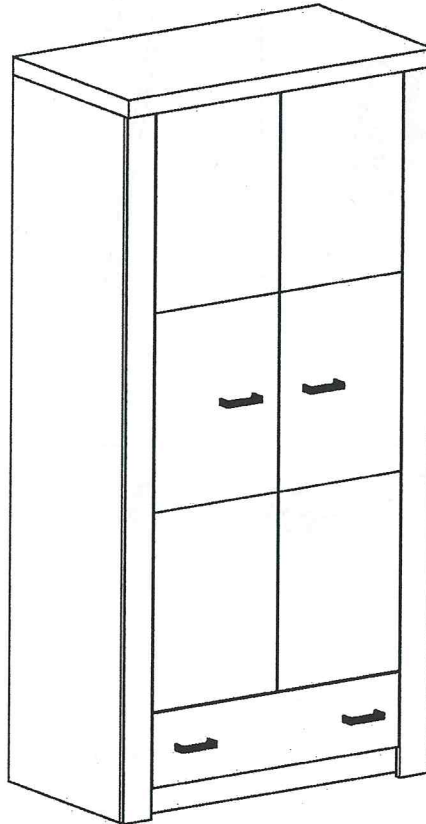

W przypadku reklamacji proszę o podanie numeru pakowacza znajdującego się na kartonie

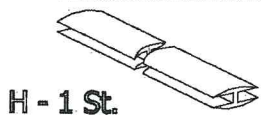

H - 1 St.



A - 12 St.

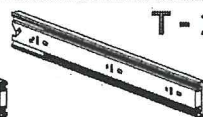
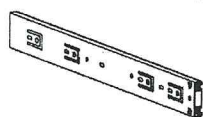

T - 1 Kpl.

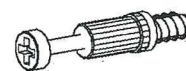

K - 14 St.



M - 25 St.
3 x 30 mm

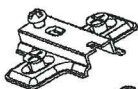

C - 6 St.



D - 6 St.



R - 1 St.



Y - 2 St.



J - 8 St.
5 x 13 mm



S - 2 St.



Z - 1 St.



U - 4 St.

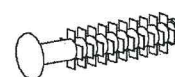

P - 4 St.

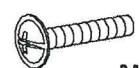

N - 8 St.
M4 x 25 mm



E - 50 St.



B - 34 St.



G - 22 St.
3,5 x 16 mm

Z - 1 St.

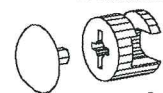
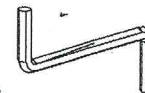

L - 14 St.

1

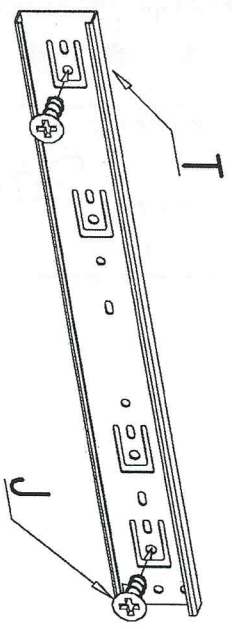
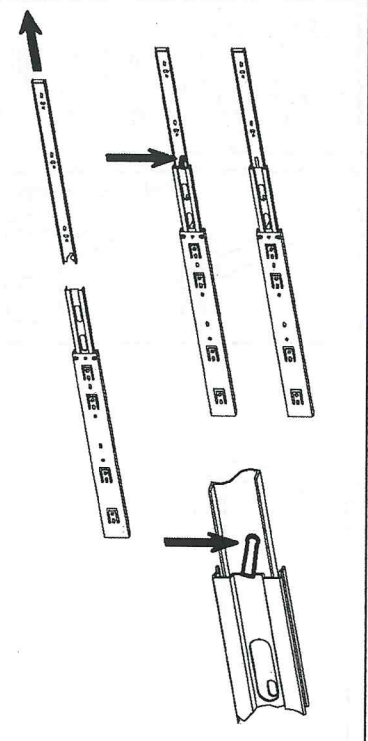
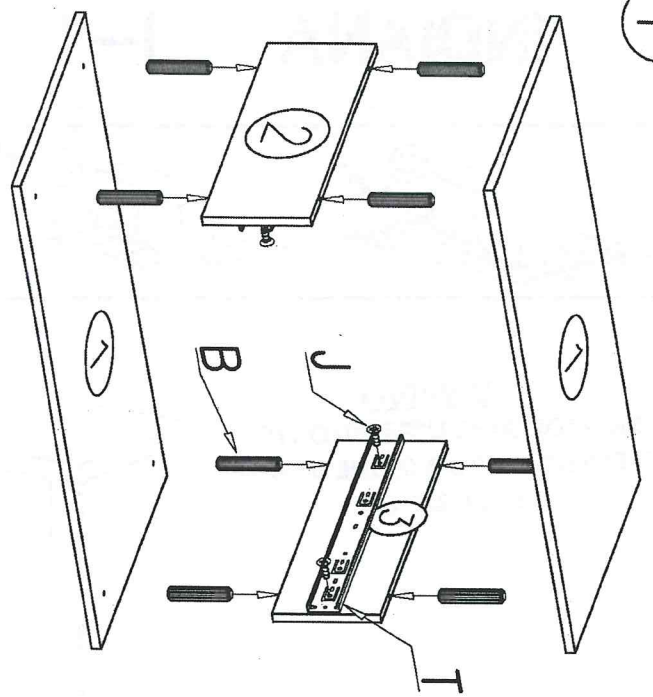

II

