

# ORLANDO 23



Narzędzia potrzebne do montażu



## UWAGA !!!

MONTOWANIE USZKODZONYCH  
ELEMENTÓW POWODUJE UTRATĘ  
GWARANCJI

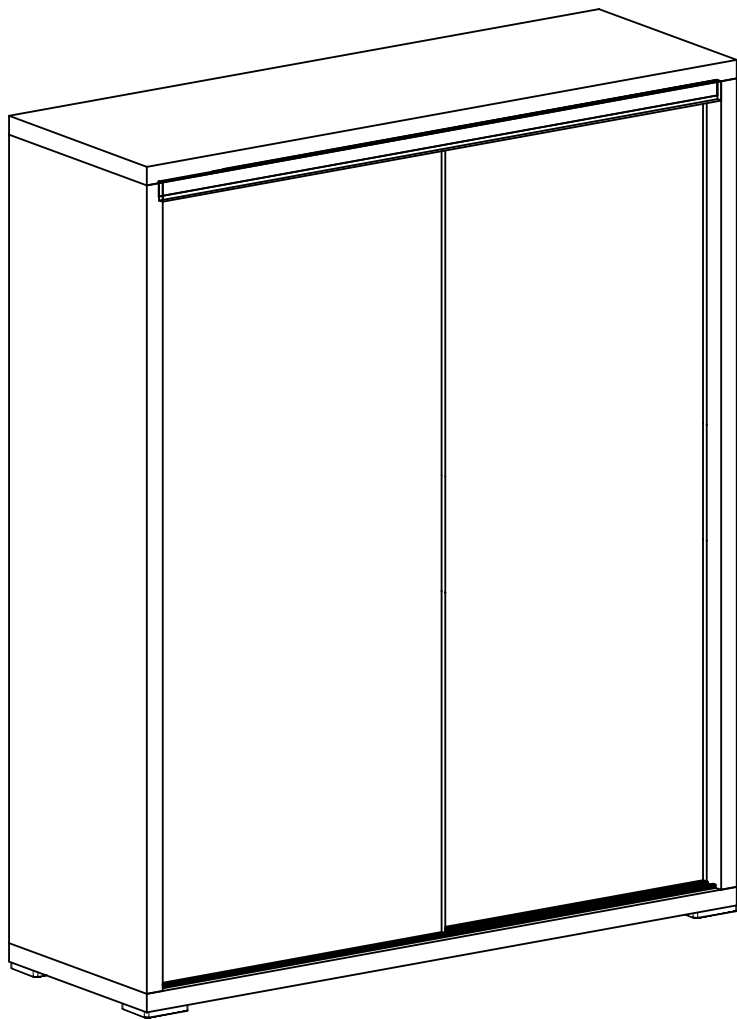

Nr	D[mm]	S[mm]	G[mm]	Ilość
1	1800	600	48	1
2	1800	600	48	1
3	2090	600	48	1
4	2090	460	16	1
5	2090	600	48	1
6	973	450	16	1
7	775	450	16	1
8	775	450	16	3
9	2120	996	2,5	1
10	2120	794	2,5	1
11	2050	870	16	1
12	2050	870	16	1
13	1700	55	16	1

W przypadku reklamacji proszę podać numer pakowacza znajdujący się na kartonie.

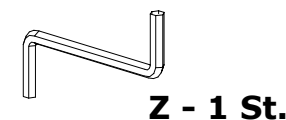
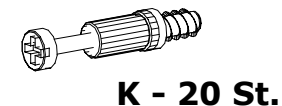
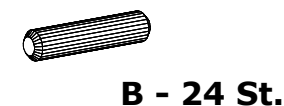
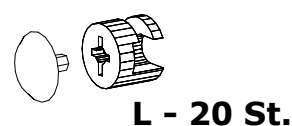
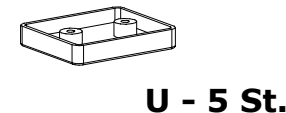
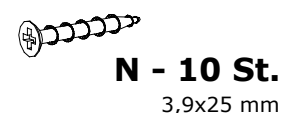
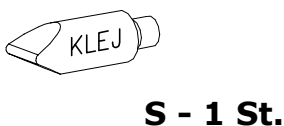
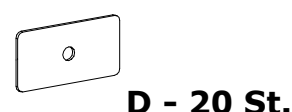
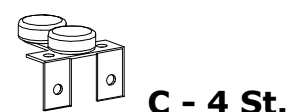
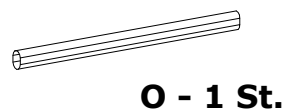
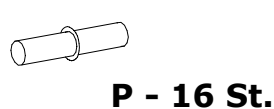
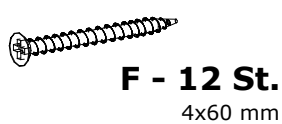
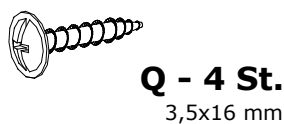
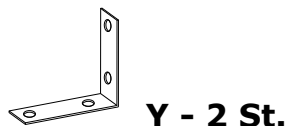

I

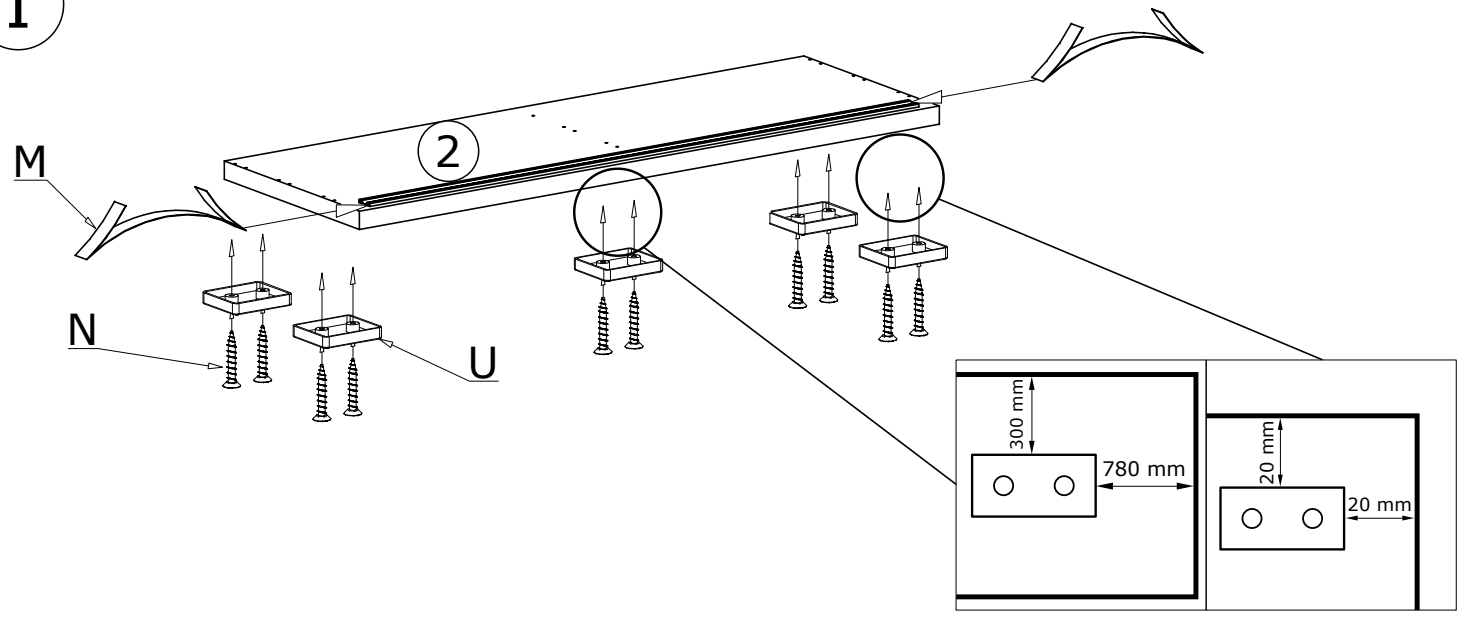

II

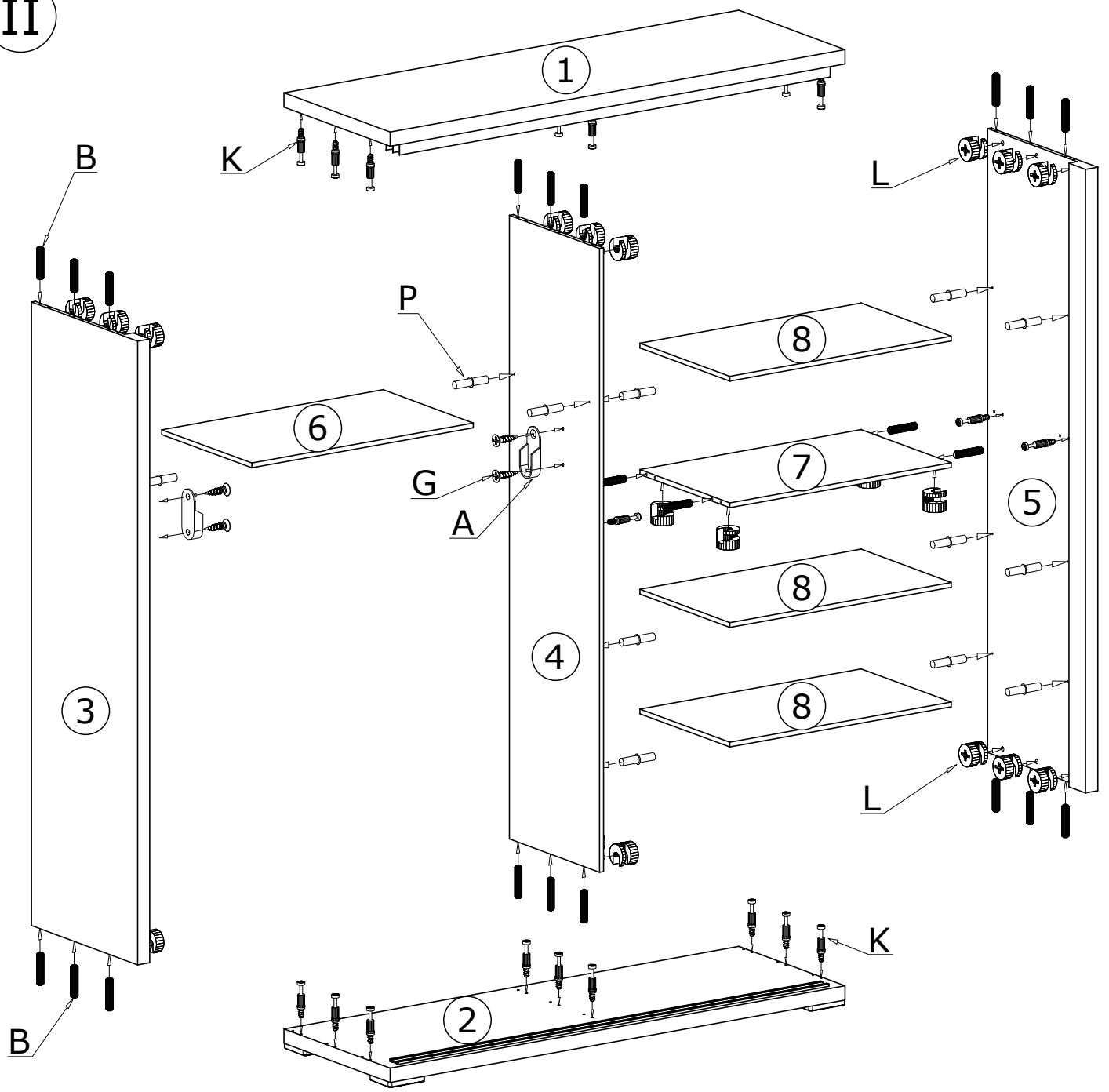

III

100X 

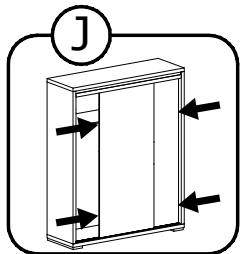
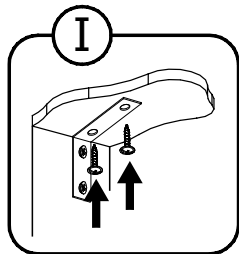
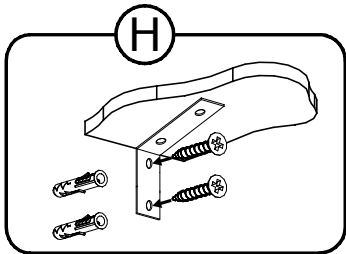
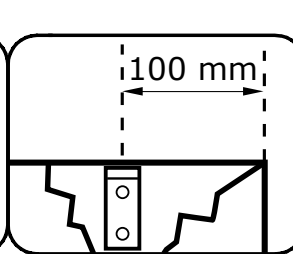
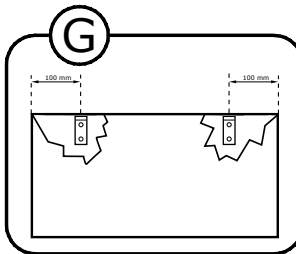
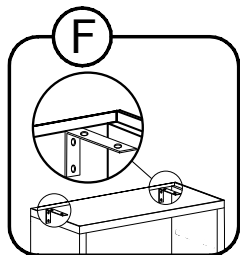
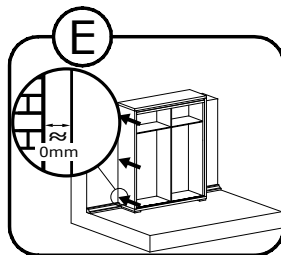
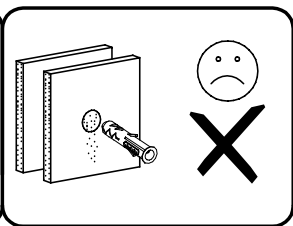
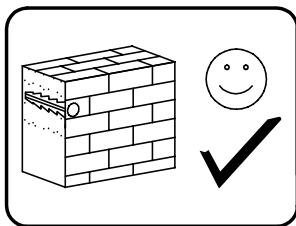
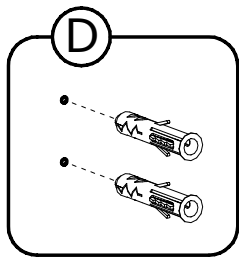
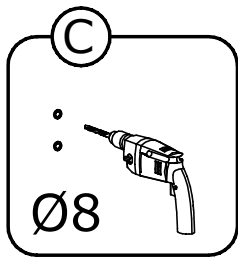
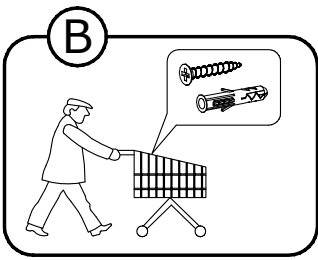
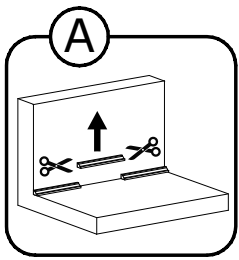
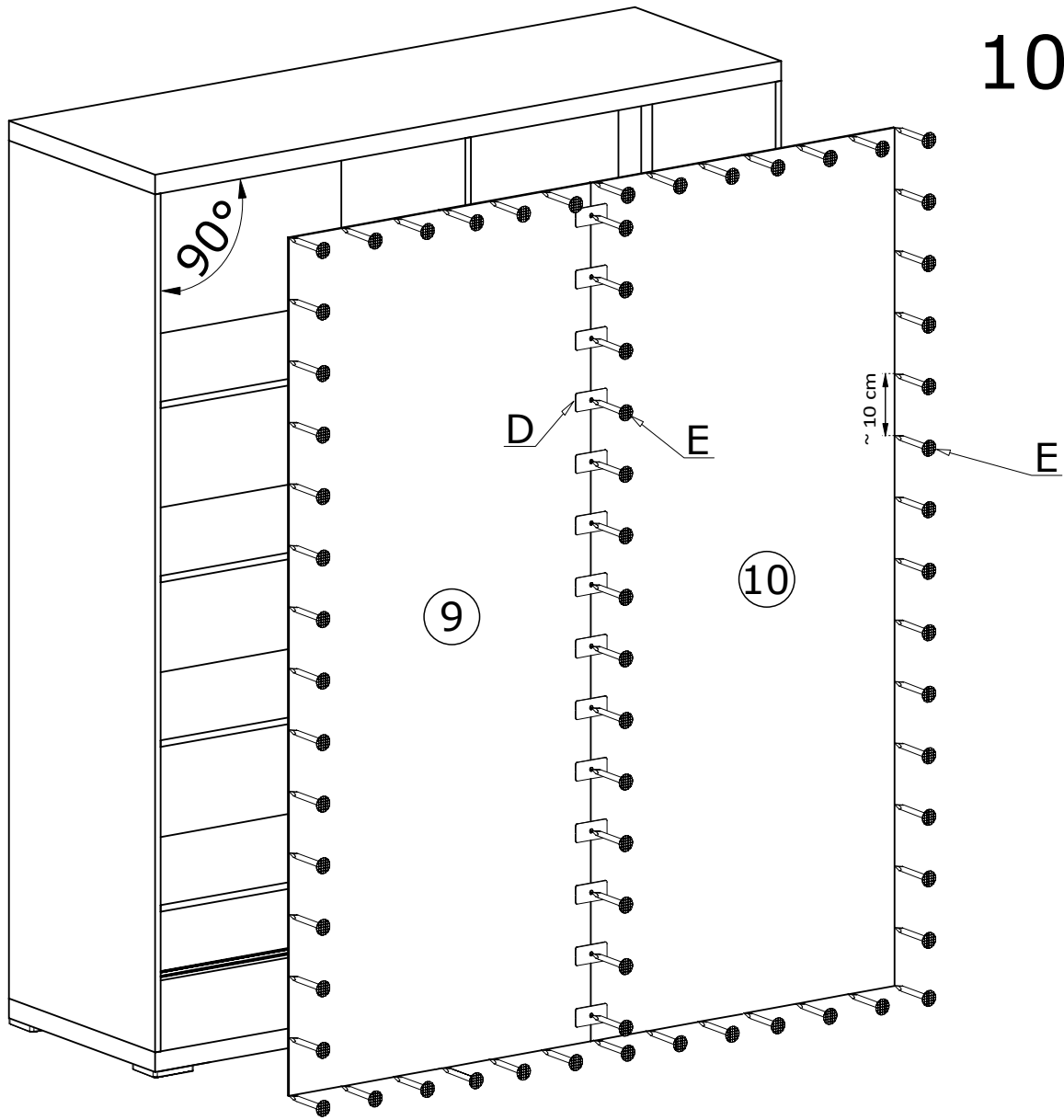

IV

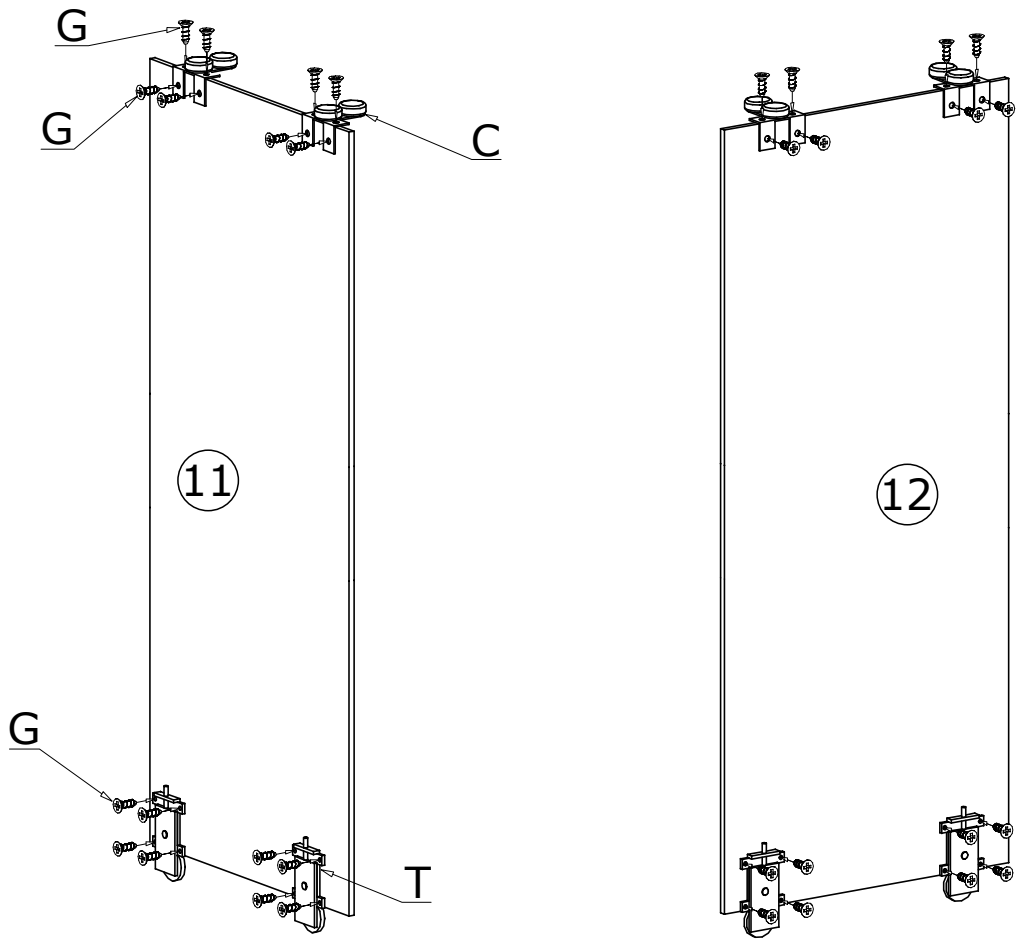

V

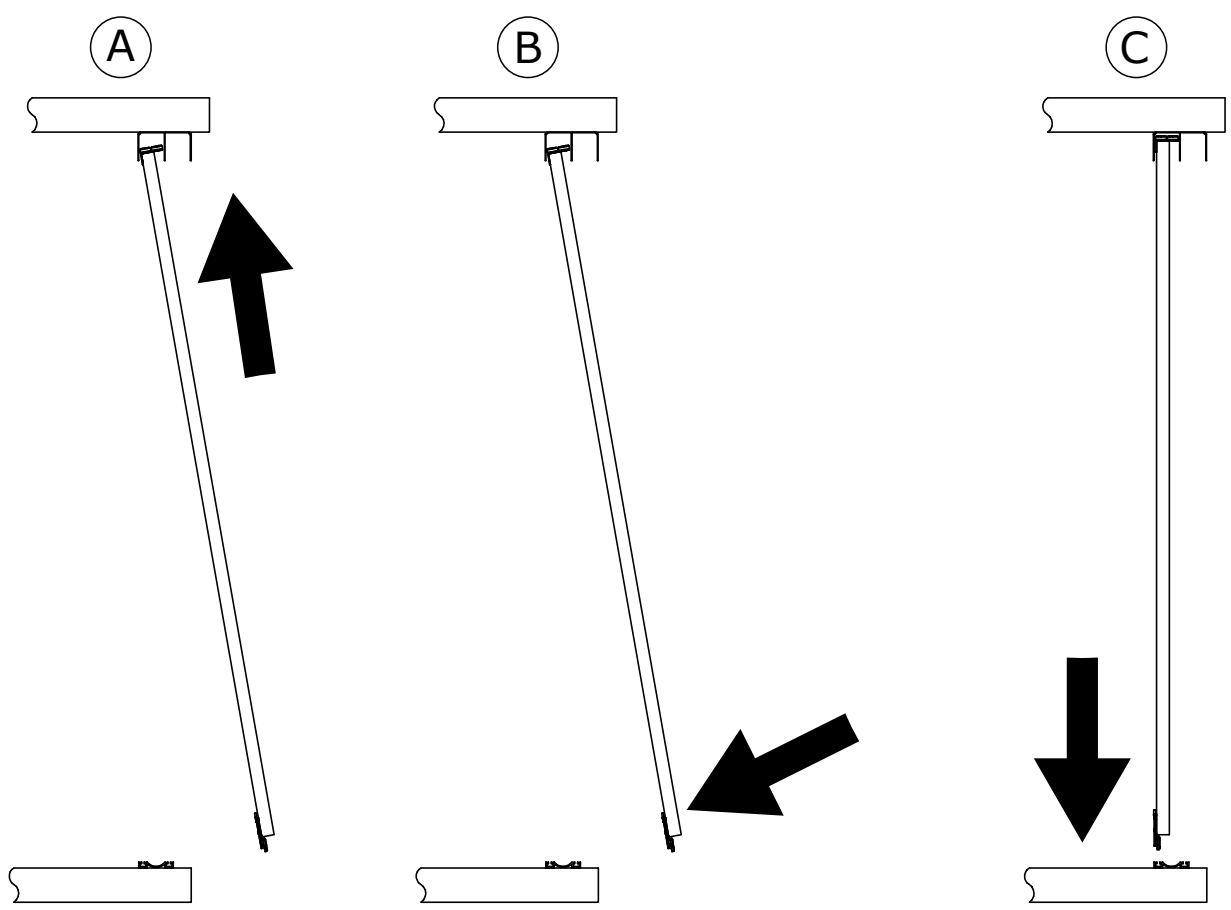

VI

