

# ORLANDO 20

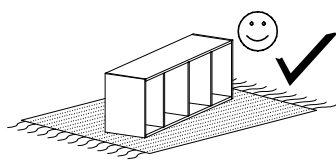

Narzędzia potrzebne do montażu

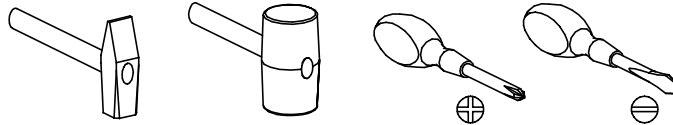

## **UWAGA !!!**

MONTOWANIE USZKODZONYCH  
ELEMENTÓW POWODUJE UTRATĘ  
GWARANCJI

Nr	D[mm]	S[mm]	G[mm]	Ilość
1	1000	700	48	1
2L	2000	200	48	1
2P	2000	200	48	1
3	1000	400	48	1
4	900	30	3	1

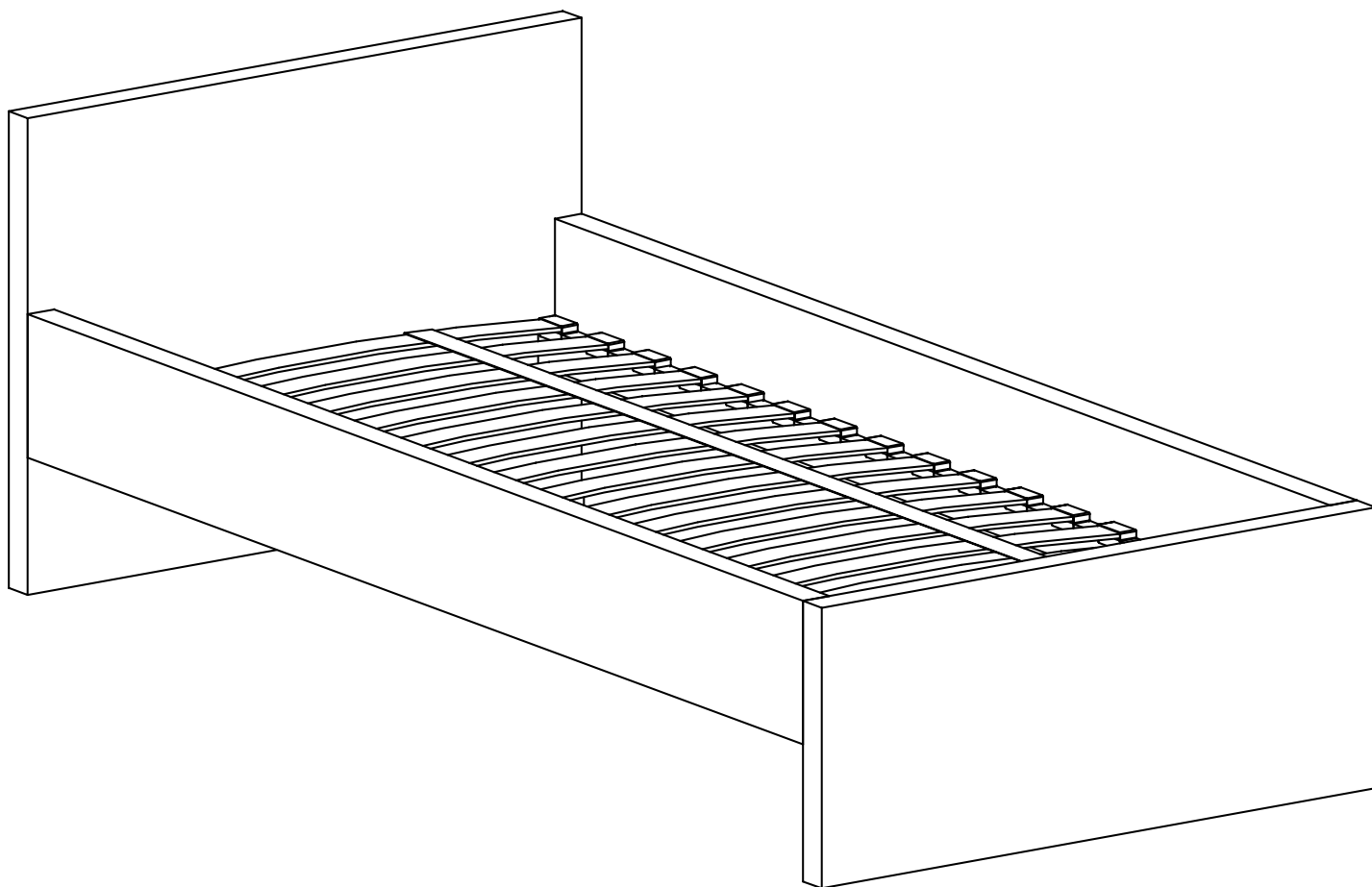

W przypadku reklamacji proszę podać numer pakowacza znajdujący się na kartonie.



**Y - 1 St.**

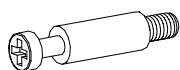

**K - 4 St.**



**L - 4 St.**

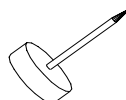

**N - 6 St.**

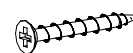

**H - 4 St.**  
3,9x30 mm

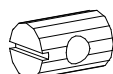

**W - 4 St.**



**B - 8 St.**



**Z - 1 St.**

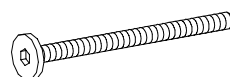

**S - 4 St.**



**G - 6 St.**  
4x35 mm

