

# ORLANDO 9

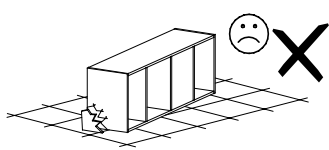

Narzędzia potrzebne do montażu

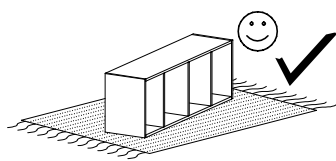

## UWAGA !!!

MONTOWANIE USZKODZONYCH  
ELEMENTÓW POWODUJE UTRATĘ  
GWARANCJI

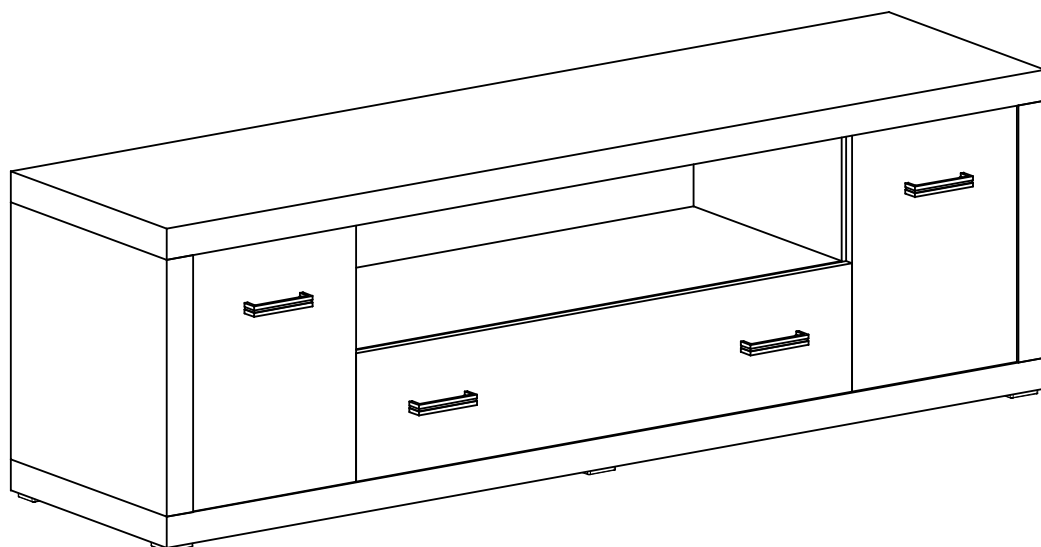

Nr	D[mm]	S[mm]	G[mm]	Ilość
1	1600	407	48	1
2	1600	407	48	1
3	400	405	48	1
4	400	388	16	1
5	400	388	16	1
6	400	405	48	1
7	342	320	16	2
8	845	388	16	1
9	1590	458	2,5	1
10	317	392	16	1
11	317	392	16	1
12	856	190	16	1
13	350	165	16	1
14	350	165	16	1
15	790	165	16	1
16	820	355	2,5	1

W przypadku reklamacji proszę podać numer pakowacza znajdujący się na kartonie.

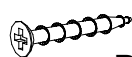

**P - 12 St.**  
3,9x25 mm

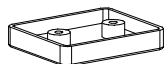

**W - 6 St.**

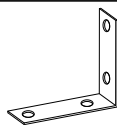

**Y - 2 St.**



**Q - 4 St.**  
3,5x16 mm



**S - 1 St.**

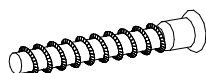

**Y - 4 St.**

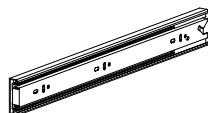

**T - 1 Kpl.**

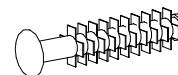

**F - 4 St.**

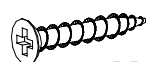

**M - 14 St.**  
3x30 mm



**J - 8 St.**  
5x13 mm

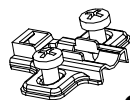

**C1 - 2 St.**

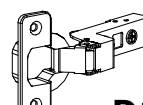

**D1 - 2 St.**



**L - 16 St.**

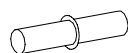

**R - 8 St.**

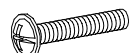

**N - 8 St.**  
5x25 mm

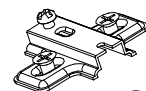

**C2 - 2 St.**

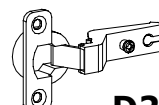

**D2 - 2 St.**



**G - 8 St.**  
3,5x16 mm



**E - 50 St.**



**B - 20 St.**

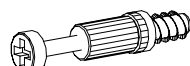

**K - 16 St.**

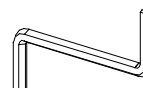

**Z - 1 St.**

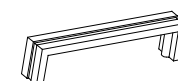

**U - 4 St.**

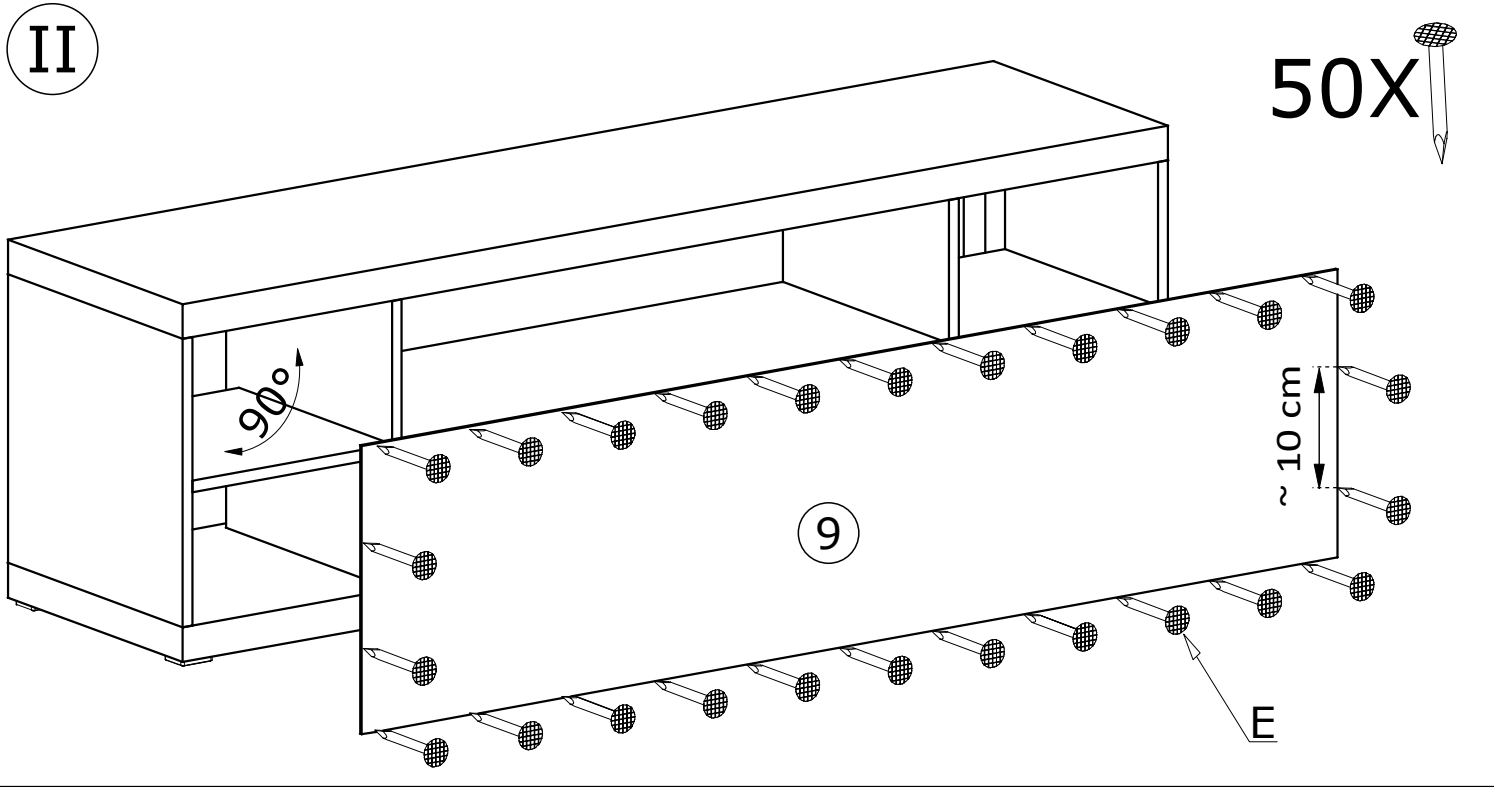
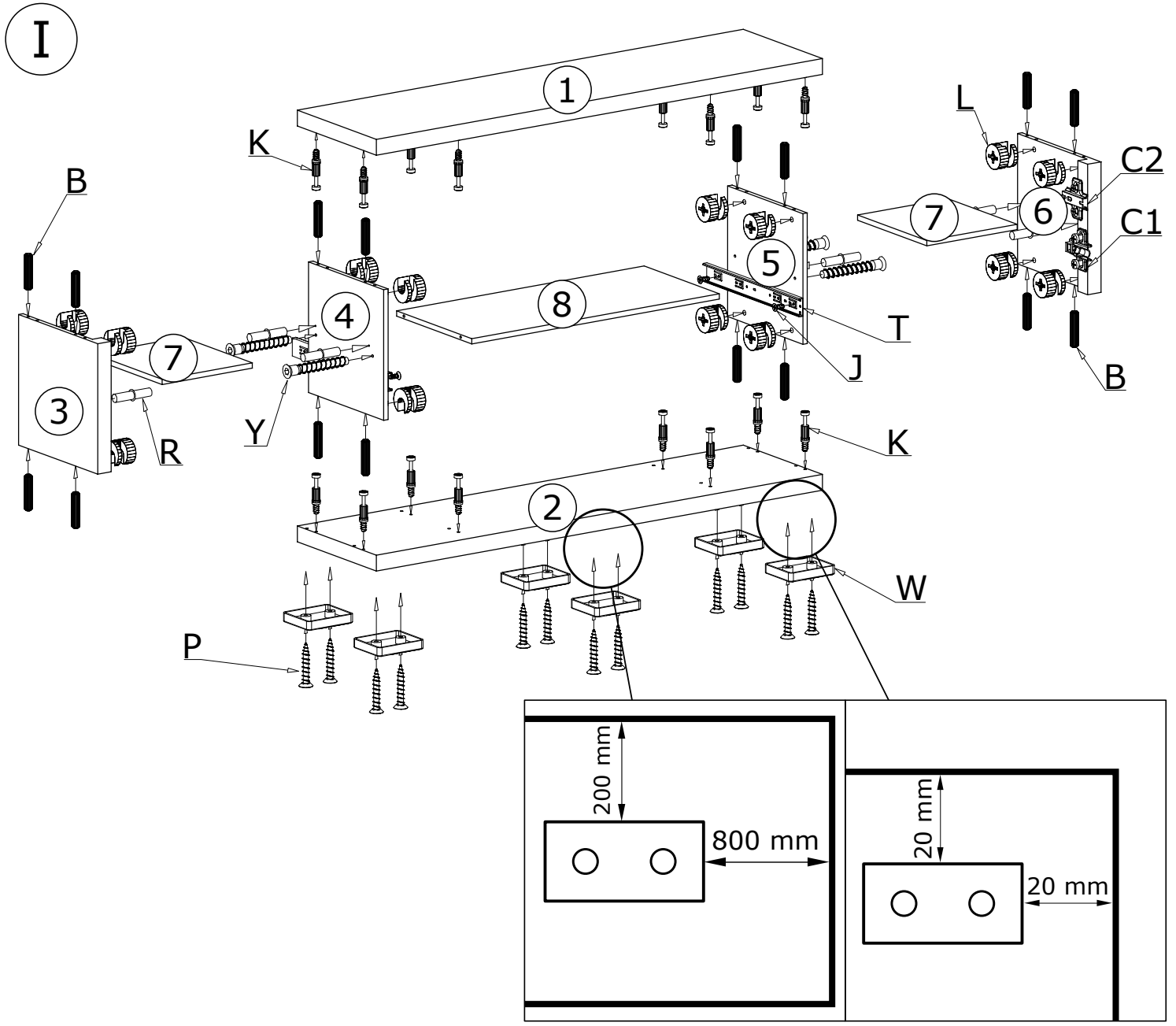

III

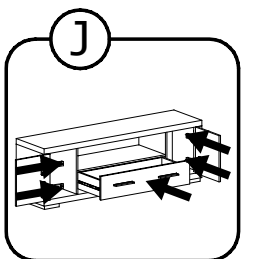
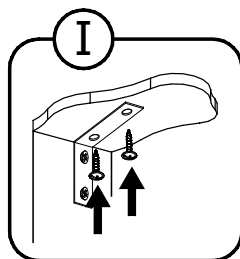
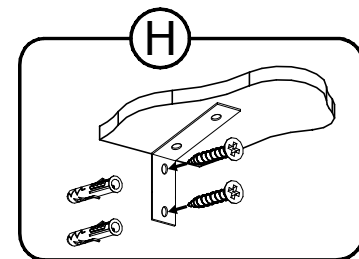
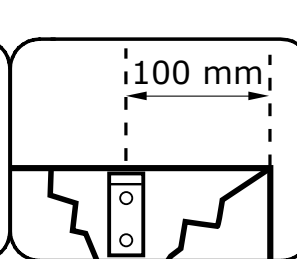
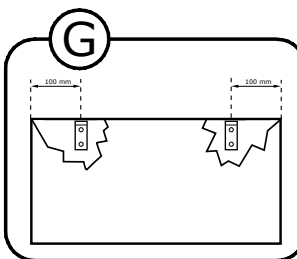
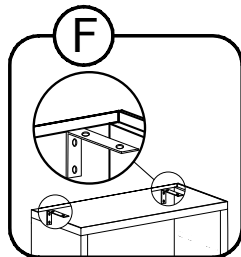
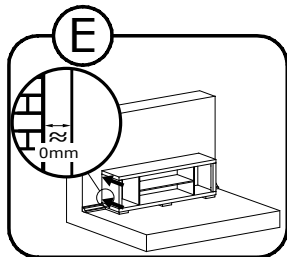
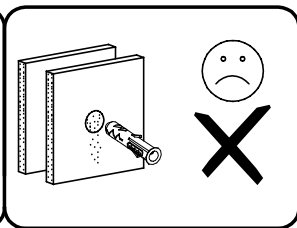
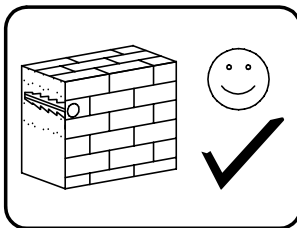
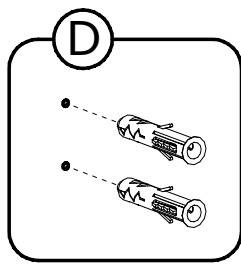
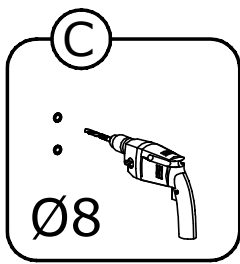
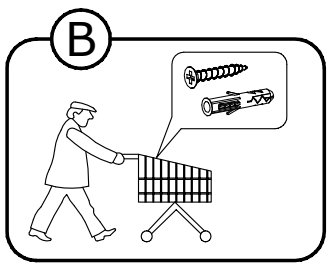
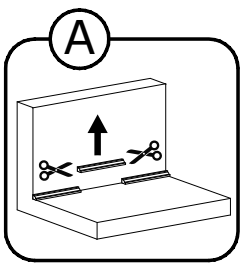
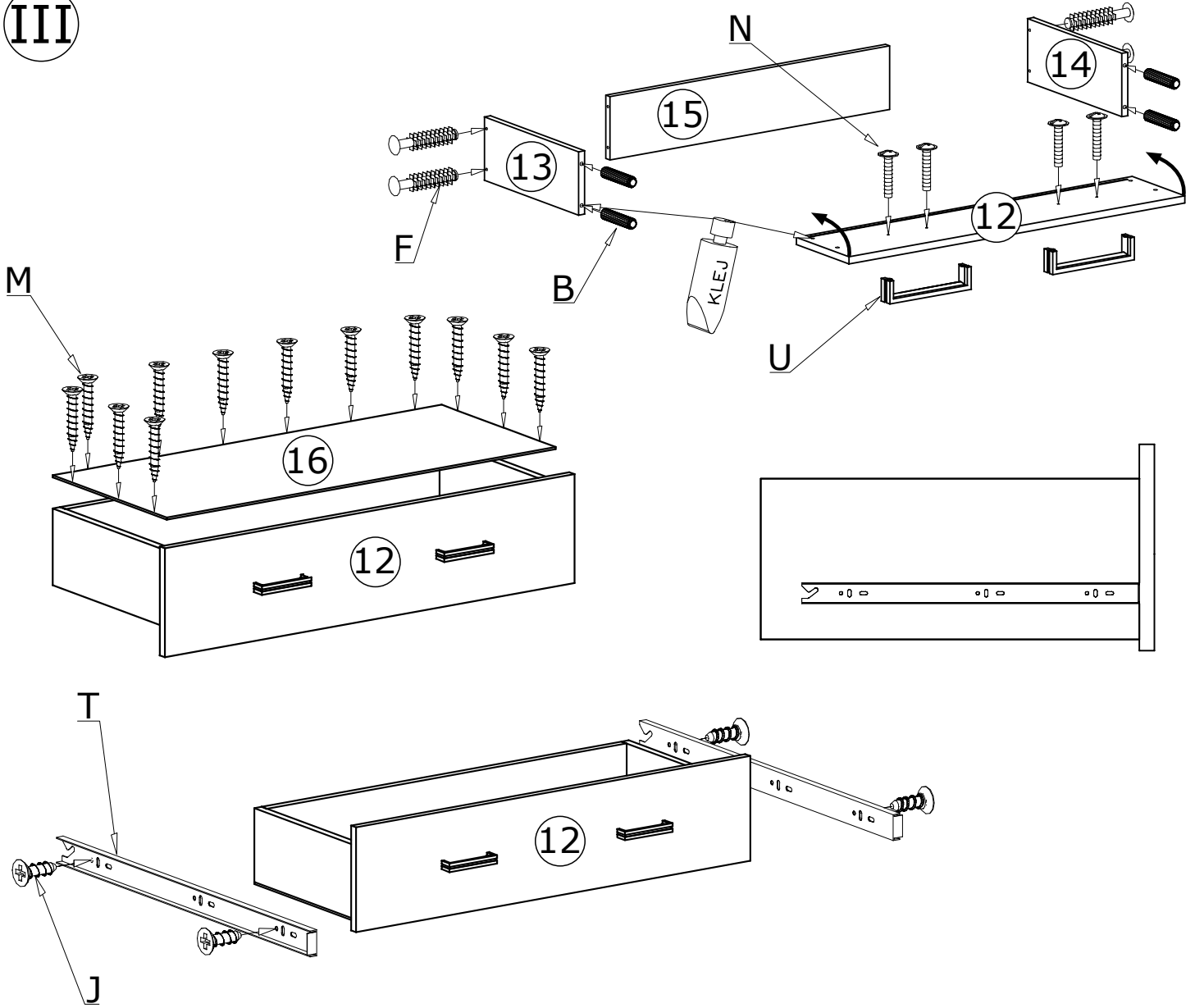

IV

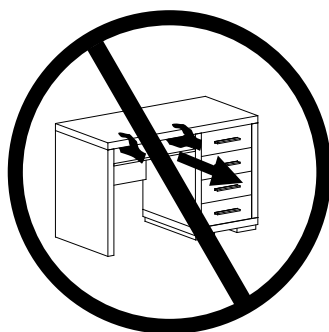
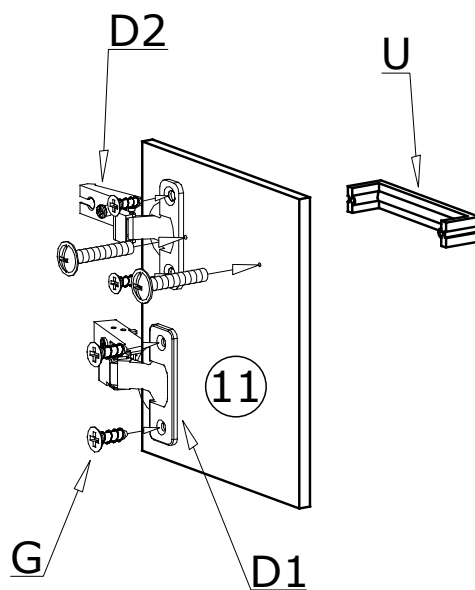
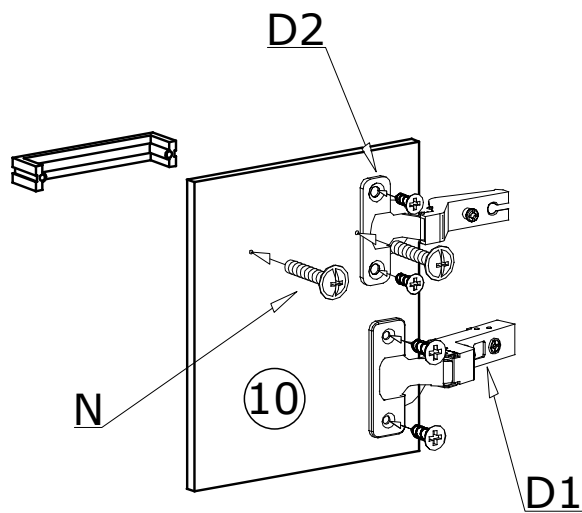
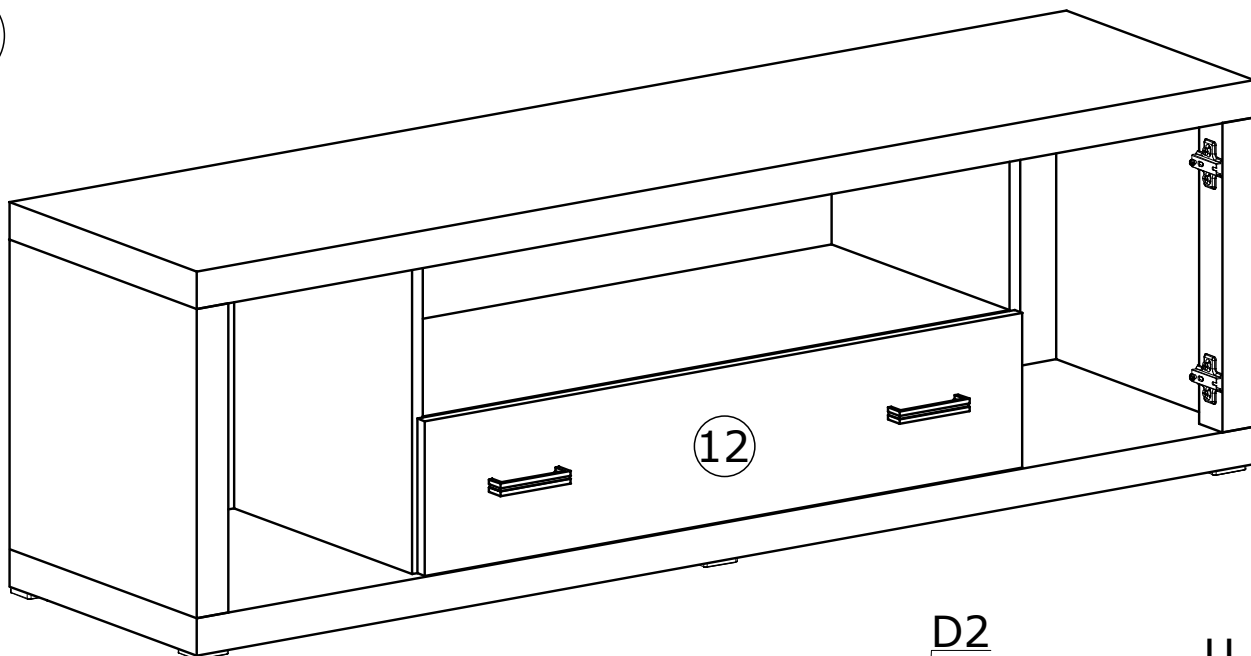

# MONTAŻ/DEMONTAŻ PROWADNIC

1

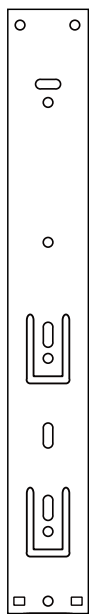

2

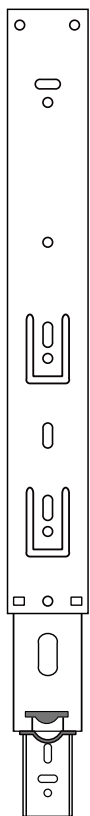

3

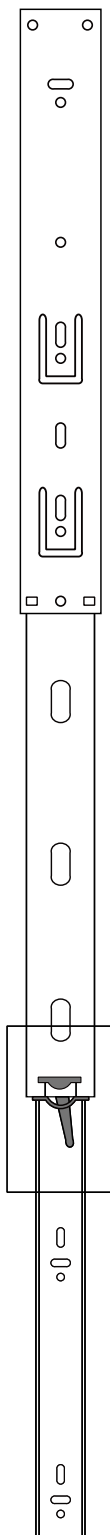

4

